

Global Connector Technology Ltd. - USB1045: USB Receptacle, Type A, 4 Pin, Surface Mount, Horizontal, Top Mount, With Plastic Locating Post

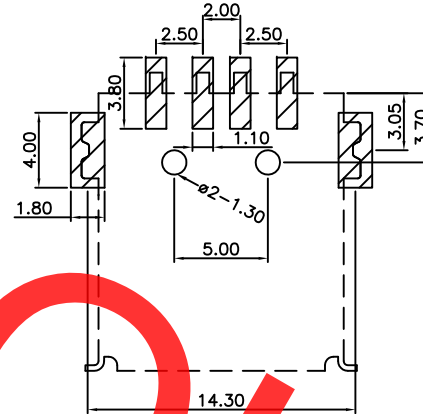

RECOMMENDED P.C.B LAYOUT

AS VIEWED FROM COMPONENT SIDE

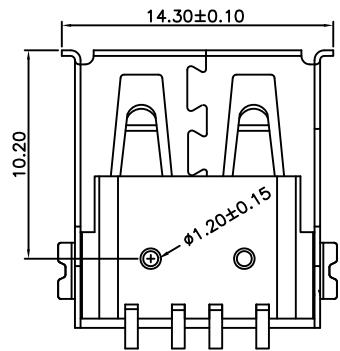
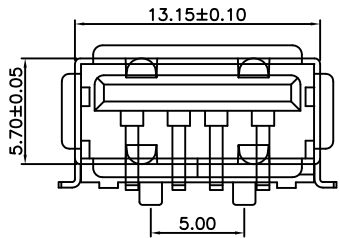
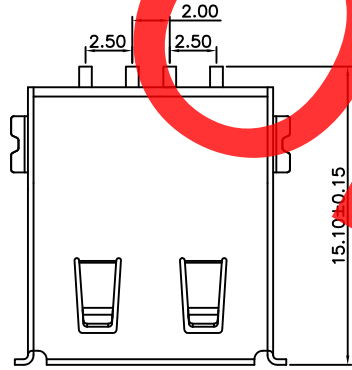
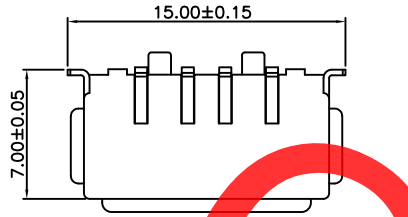
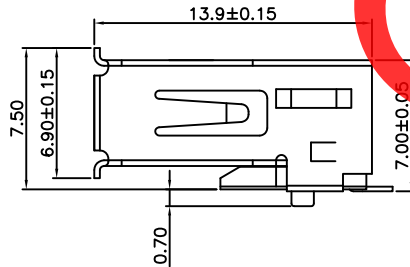

Ordering Grid

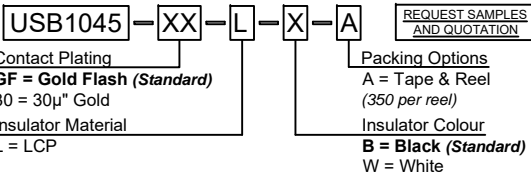

Contact Plating
GF = Gold Flash (Standard)
 30 = 30µ" Gold
 Insulator Material
 L = LCP

Packing Options
 A = Tape & Reel
 (350 per reel)
 Insulator Colour
B = Black (Standard)
 W = White

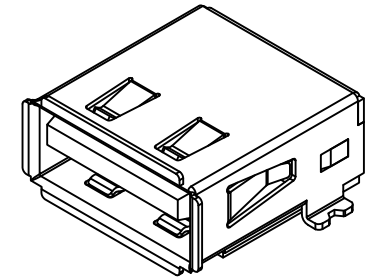

Specifications 规格:

Materials & Plating 物料与电镀:

Plastic Housing 塑胶外壳: Thermoplastic, LCP, UL94V-0
 热塑性塑料, LCP, UL94V-0;

Contact Terminal 接触端子: Phosphor Bronze 磷铜

Metallic Shell 金属外壳: Brass 黄铜

Finish 表面处理:

Underplating 底层电镀: 50µ" Nickel 50µ" 镍

Plating 电镀:

Contact Area: Gold Flash or 30µ" Gold 闪金或30µ"金

Solder Tails 焊接末端: 50µ" Tin 50µ" 锡

Metallic Shell 金属外壳: Nickel 镍

Electrical 电气规格:

Voltage Rating 电压额定值: 30V AC/DC

Current Rating 电流额定值: 1.5A AC/DC

Operating Temperature 工作温度: -25°C to +80°C

Contact Resistance 接触电阻值: 30 mΩ max.

Insulating Resistance 绝缘电阻值: 1000 MΩ min.

Dielectric Withstand Voltage 耐压: 500V AC

Mechanical 机械性规格:

Mating Force 插入力: 35N (3.57Kgf) max.

Unmating Force 拔出力: 10N (1.02Kgf) min.

Durability 耐久性: 1,500 Cycles 1500次插拔

By	SA	AJO	AJO
DETAIL	DRAWING RELEASE	PCN USB 1045-001	USB1045 X EOLN
REV DATE	A 14/02/11	B 26/11/13	X 11/05/16



Tolerances (Except as noted)	Part Number:-	Date:-
Dimensions in mm	USB1045	14 FEB 11
X.X ±0.3	X.XX ±0.2	Description:- USB Receptacle, Type A, 4 Pin, Surface Mount, Horizontal, Top Mount, with Locating Post
X.XX ±0.20	X.XX* ±1*	
X.XXX ±0.100	X.XXX* ±0.5*	
Third Angle Projection	THIS DRAWING IS CONFIDENTIAL AND MUST NOT BE COPIED OR DISCLOSED WITHOUT WRITTEN CONSENT	

GCT				
www.gct.co				
Scale	Revision	Material	Drawn by	Sheet No.
NTS	X	See Note	SA	E & OE 1/2

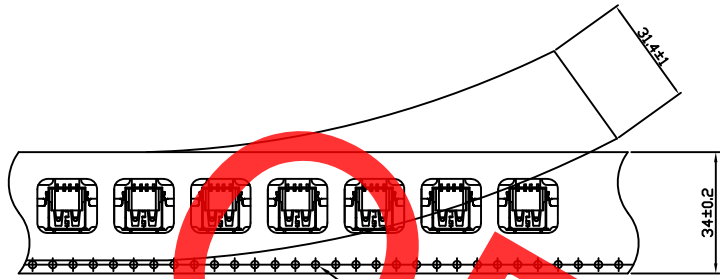

I/O Direction
卷盤繞逆時針方向轉動

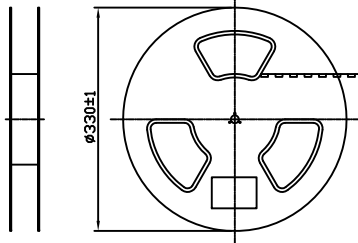

⇨ (I/O) DIRECTION

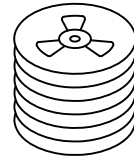
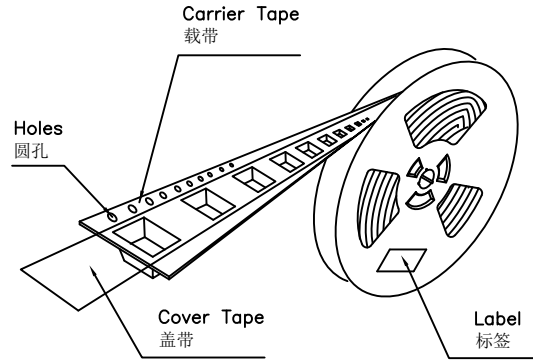

4 cardboard folded triangles fitted in corners for protection
4纸板保护四角装有折叠的三角形

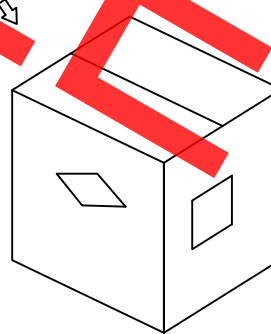
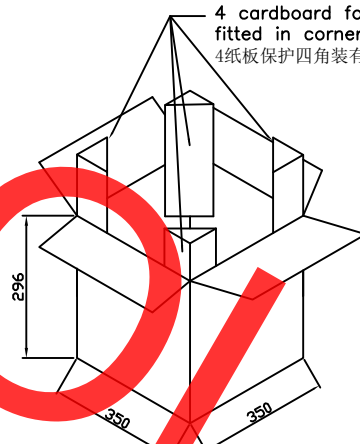

Products P/N	PCS/Reel	Reels/Carton	PCS/Carton
USB1045-XX-L-X-A	350	7	2450

Notes注意:
1.Part Conforms to EIA-481-C Standards产品符合EIA-481-C标准
2.All dimensions in millimeters 所有尺寸均是毫米

By	SA	AJO	AJO
DETAIL	DRAWING RELEASE	PCN USB 1045-001	USB1045 X EOLN
REV DATE	A 14/02/11	B 26/11/13	X 11/05/16



Tolerances (Except as noted)	Part Number:-	Date:-
Dimensions in mm	USB1045	14 FEB 11
	Description:-	
	USB Receptacle, Type A, 4 Pin, Surface Mount, Horizontal, Top Mount, with Locating Post	
Third Angle Projection	THIS DRAWING IS CONFIDENTIAL AND MUST NOT BE COPIED OR DISCLOSED WITHOUT WRITTEN CONSENT	

GCT				
www.gct.co				
Scale NTS	Revision X	Material See Note	Drawn by SA	Sheet No. 2/2